

INSTRUCTION MANUAL FOR

BLUED &
STAINLESS
STEEL



CALIBER
.50 Round or
Conical Ball
**BLACK POWDER OR
PYRODEX ONLY**

RUGER® **MODEL 77/50™**

**INLINE MUZZLELOADING BLACK POWDER
PERCUSSION RIFLE**



**READ THE INSTRUCTIONS AND
WARNINGS IN THIS MANUAL CAREFULLY
BEFORE USING THIS FIREARM**

**For Product Service on This Model Please Call:
(603) 863-3300 (See p. 38)**

**STURM, RUGER & Company, Inc.
Southport, Connecticut 06490 U.S.A.**

THIS INSTRUCTION MANUAL SHOULD ALWAYS ACCOMPANY THIS FIREARM AND BE
TRANSFERRED WITH IT UPON CHANGE OF OWNERSHIP, OR WHEN THE FIREARM IS LOANED OR
PRESENTED TO ANOTHER PERSON.

FIREARMS SAFETY-YOUR RESPONSIBILITY

SAFETY MUST BE THE FIRST AND CONSTANT CONSIDERATION OF EVERY PERSON WHO HANDLES FIREARMS AND AMMUNITION.

This Instruction Manual is designed to assist you in learning how to use and care for your **RUGER® MODEL 77/50™** muzzleloading rifle properly.

Only when you are certain you fully understand the Manual and can properly carry out its instructions should you practice loading, etc. with live ammunition.

If you have any doubts about your ability to handle or use a particular type of gun safely, then you should seek supervised instruction.

Such personalized instruction is often available from gun dealers, gun clubs or police departments. If none of these sources can help you, write to the National Rifle Association, 11250 Waples Mill Road, Fairfax, VA 22030-7400. They will assist you.

The person with a gun in their possession has a full-time job. You cannot guess; you cannot forget. You must know how to use your firearm safely. **Do not use any firearm without having a complete understanding of its particular characteristics and safe use.**

Remember: There is no such thing as a foolproof gun.

TABLE OF CONTENTS

	Page
General Information	3
Operation of Safety	6
Ammunition	7
Eye and Ear Protection	11
To Load and Fire	11
To Unload	20
Basic Disassembly and Reassembly	22
Care and Cleaning	27
Regarding Accuracy	34
To Clear a Malfunction ("Jam")	35
Maintenance of Stainless Steel Components	36
Attaching Scope Rings	36
Sight Adjustment	37
Service and Parts Policy	38
Parts Drawing	42
The Basic Rules of Safe Firearms Handling	43
Warranty Information	48

"Ruger®" is a registered U.S. trademark.

"77/50™" is a trademark of Sturm, Ruger & Co., Inc.



WARNINGS OF GREAT IMPORTANCE ARE FOUND ON THE FOLLOWING PAGES:

Alterations	3	Firing	17
Manual Safety	7	Reloading	18
Lead Exposure	7	Mishandling	19
Ammunition	8	Disassembly	22
Black Powder	9	Lubrication	29
Percussion Caps	11	Storage	30
Loading	13	Malfunctions	35
Handling	17	Parts Purchasers	39

OTHER CAUTIONS AND WARNINGS APPEAR THROUGHOUT THE MANUAL.

FIREARMS ARE DANGEROUS WEAPONS – MUZZLELOADING BLACK POWDER FIREARMS REQUIRE SPECIAL PRECAUTIONS.

READ THE INSTRUCTIONS AND WARNINGS IN THIS MANUAL THOROUGHLY AND CAREFULLY BEFORE USING.



WARNING-ALTERATIONS



This product was designed to function properly in its original condition. Alterations can make it unsafe. Do not alter any part or add or substitute parts or accessories not made by Sturm, Ruger & Co. Inc.

DO NOT ALTER ANY GUN

GENERAL INFORMATION AND MECHANICAL CHARACTERISTICS

The rifle you have chosen, the **RUGER® MODEL 77/50** muzzleloading rifle, is an original Ruger design. It is manufactured to our regular standards of strength and reliability entirely in modern Ruger factories in the U.S.A. High quality steels and coil springs are used throughout, the same as in our centerfire rifles. It is a bolt-action, single shot, muzzleloading black powder rifle of modern design. It gives the black powder shooter many of the convenience and safety features of modern Ruger centerfire rifles, combined with traditional muzzleloading rifle characteristics. It is particularly useful for black powder hunting and target shooting.

The **RUGER® MODEL 77/50** is a muzzleloading, percussion rifle intended for use with black powder, percussion caps, soft lead and jacketed “saboted” projectiles. It has a precision rifled barrel with a 1-in-28” rifling twist. It does not fire conventional cartridges, but is instead loaded from the muzzle of the barrel. It is of bolt-action operation, and must be cocked and capped by opening the bolt, placing a cap on the nipple, and then closing the bolt before normally firing the rifle by pulling the trigger.

Like any such rifle, it is to be **USED WITH BLACK POWDER OR PYRODEX ONLY**, and its safe use requires that the shooter be thoroughly familiar with the special characteristics of these firearms.

Other notable features of the **RUGER® MODEL 77/50** rifle include: A three-position safety; in-line bolt action ignition; a fast lock-time trigger mechanism (non-adjustable); a flush positioned bolt stop (bolt release); a hardwood stock with a rubber recoil pad; and studs to which sling swivels can be attached.

The receiver of the **RUGER® MODEL 77/50** rifle incorporates integral scope mount bases (see illustration next page). It also comes with open sights – a gold bead front sight and a folding leaf rear sight which is adjustable for elevation and windage.

Disassembly of the rifle to its major components is readily accomplished by removal of two screws and the barrel band. The bolt assembly can be quickly disassembled for cleaning.

All mechanical components are made of heat-treated chrome-molybdenum or stainless steel, with music wire coil springs throughout the mechanism.

The mechanism of the **RUGER® MODEL 77/50** provides for security against accidental discharge when properly handled. As with any other firearm, however, it must be used with strict attention to correct safety practices, some of which are unique to muzzleloading firearms. In addition, the rifle should be inspected frequently to assure that it is working properly.

The **RUGER® MODEL 77/50 Officer’s Model** has the same mechanism and operation as the standard Model 77/50, but is furnished with a special straight-gripped walnut stock with cut-checked grip and forend and a curved butt plate reminiscent of the “Officer’s Model” Springfield rifles privately purchased by Calvary officers over a century ago.

The **RUGER® MODEL 77/50** is also available in stainless steel construction with a laminated stock, for increased corrosion resistance and protection from the elements.

NOMENCLATURE

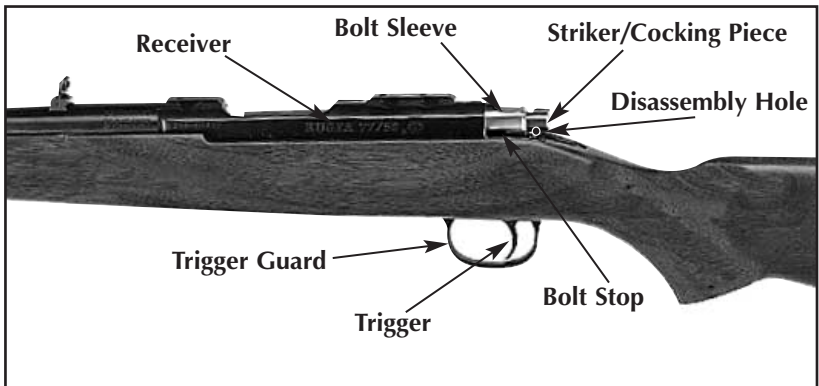
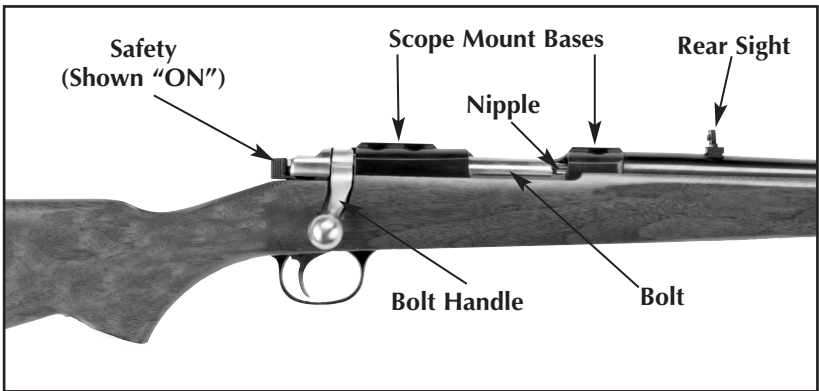
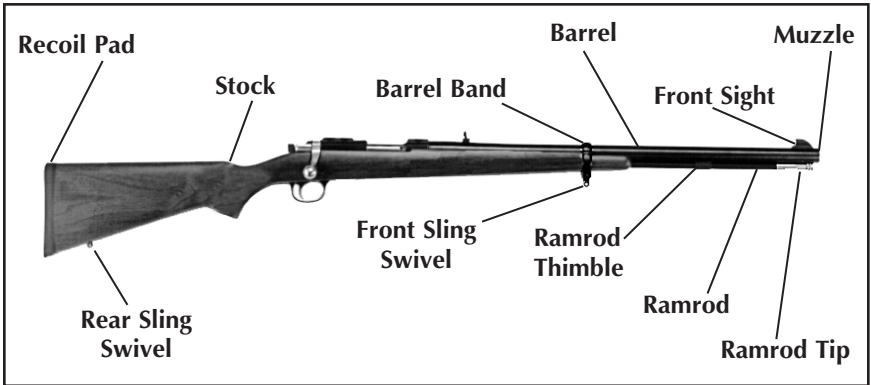

Figure 1. Components frequently referred to are identified. In these photographs the cocking piece is shown cocked (protruding from the rear of the bolt sleeve) revealing the disassembly hole in the lower portion of the cocked piece. The bolt stop (on the left side of the receiver) permits the bolt to be withdrawn simply by pressing down lightly with the thumbnail. The safety selector (shown in the "Safe" position) should be in the "Load-Unload" position when the bolt is being removed or being installed.

OPERATION OF SAFETY

The **RUGER® MODEL 77/50** rifle has a three position safety. The safety selector is located at the right of the bolt sleeve.

The safety selector can be moved from the “Fire” position to its two other positions (“Load-Unload” and “Safe”) only when the striker is cocked. Fully raising the bolt handle cocks the striker.

The bolt handle can be raised and lowered only when the safety selector is in either the full forward “Fire” or the middle “Load-Unload” position. When the safety selector is in the full rearward “Safe” position, the bolt handle is locked in the closed (fully down) position in order to prevent inadvertent lifting of the bolt handle and to ensure that the rifle will be ready to fire when the safety is taken “off”.

Practice (with an unloaded rifle) moving the safety selector to the three positions until you know the position of the safety selector for the three modes– “Fire,” “Load-Unload,” and “Safe.” **WARNING: When manipulating the safety selector, DO NOT HAVE ANY FINGER INSIDE THE TRIGGER GUARD! When the safety selector is in the “Fire” position and the trigger is pulled, the rifle will fire.**

The safety selector should always be in the “Safe” position except when the gun user is actually firing or unloading the rifle. The safety selector should unfailingly be moved to the “Safe” position whenever the gun user ceases firing.

SAFETY POSITIONS

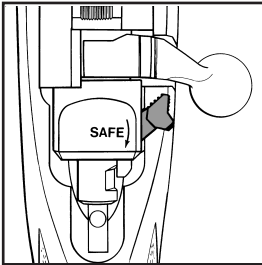

Figure 2. Safety selector in “**FIRE**” (full forward) position. The safety selector should be moved to this position only when the gun user is actually firing the rifle. When the safety is in the fire position, it is referred to as being “on.” (When the safety is in the “SAFE” position, shown in Figure 4, it is referred to as being “off.”)

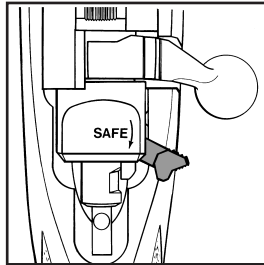

Figure 3. Safety selector in “**LOAD-UNLOAD**” (middle) position. The safety selector should be in this position when the bolt is being cycled, to place a percussion cap on the nipple, to remove a percussion cap from the nipple, or when unloading the rifle. As soon as the bolt is closed, the safety selector should be moved fully rearward to the “SAFE” position shown in Figure 4, unless the rifle is to be fired immediately.

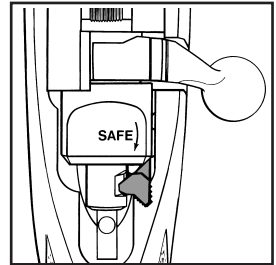
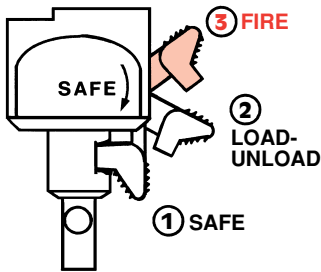

Figure 4. Safety selector in “**SAFE**” (full rearward) position. The safety selector is fully nested in the groove in the cocking piece. When the safety selector is in this position, the bolt handle cannot be raised. The curved arrow on the bolt sleeve indicates the direction and motion of the safety selector to bring it to the “SAFE” position. **Keep the safety in this position except when actually loading, capping, unloading, or firing.**



WARNING – MANUAL SAFETY



Keep the safety on unless actually firing. Always move the safety fully to its intended position and check it. The safety has three positions –“SAFE,” “LOAD-UNLOAD,” and “FIRE.” Never depend on a safety mechanism or any other mechanical device to justify careless handling or permitting the rifle to point in an unsafe direction. The only “safe” rifle is one in which the bolt is open, the barrel is empty of both powder and projectile, and the nipple is uncapped.

KNOW HOW TO USE THE SAFETY

The safety selector is held in each of its positions by a plunger that is under spring tension. Therefore, the gun user should frequently check the position of the safety selector to be certain it has not been inadvertently moved. If the safety does not function properly, or if the selector seems to move too easily, or if the safety selector does not seem firmly positioned in any of its three positions, the rifle should be discontinued from use and returned to the Newport Product Service Department for repair (See p. 38).



WARNING – LEAD EXPOSURE



Discharging firearms in poorly ventilated areas, cleaning firearms, or handling ammunition may result in exposure to lead and other substances known to the state of California to cause birth defects, reproductive harm, and other serious physical injury. Have adequate ventilation at all times. Wash hands thoroughly after exposure.

SHOOTING OR CLEANING GUNS MAY EXPOSE YOU TO LEAD

AMMUNITION

BLACK POWDER OR PYRODEX ONLY





The **RUGER® MODEL 77/50** is a single shot muzzleloading percussion rifle intended solely for use with Black Powder or Pyrodex. **It should never, under any circumstances, be loaded with any type of smokeless powder as the result could be damage to the rifle and injury to the shooter or bystanders. Be aware that certain smokeless powders may appear black in color even though they are not Black Powder! Never use any powder that you are not certain is actually Black Powder.** The best way to do this is to only use powder from clearly marked original cans of Black Powder or Pyrodex.

Black Powder is usually classified by powder grain size, with “Fg” being the largest granulation and “FFFFg” being the smallest granulation normally available. Use only “FFg” (sometimes called “2F”) grain size black powder in the **RUGER® MODEL 77/50** rifle. Replica Black Powder such as Pyrodex RS may be used, so long as suggested loading data is strictly adhered to. Note that Pyrodex RS is less dense than FFg black powder and must only be used as a measure-for-measure substitute for FFg black powder. **If you substitute Pyrodex RS for FFg black powder on a weight-for-weight basis, you will overcharge your rifle and risk serious injury.**

POWDER CHARGE

Since Black Powder is sold in bulk, you are in complete control over how you load your rifle. Be sure to weigh each charge, or use a dipper which holds the exact weight of powder you wish to load. Check to be sure the dipper holds the correct amount of powder by weighing a dipper-full of powder before you begin loading your rifle from the dipper. **Never load powder into the barrel directly from a flask or other powder container -- you run the serious risk of explosion and severe personal injury.**

A good starting accuracy load, using a pure lead .50” diameter ball or conical projectile, is 40 grains of FFg black powder. You may find that adjustment of this charge upward or downward is more accurate in your rifle. A good starting hunting load for deer-sized game with the same projectile is 70 grains of FFg black powder. Consulting a black powder loading manual for recommended target or hunting loads is essential. **Never exceed the maximum powder charge listed for the specific projectile you are using! Never exceed a powder charge of 120 grains of FFg black powder, regardless of the projectile you are using!**

 WARNING – AMMUNITION	
 <p>Never Use Unknown or Smokless Powder</p> 	Death, serious injury, and damage can result from the use of wrong ammunition, bore obstructions, powder overloads, or incorrect components. <u>Always</u> wear shooting glasses and hearing protectors.
	Never use smokeless powder in any muzzleloader! Never fire an unknown powder charge. If you are uncertain as to which components your rifle is loaded with, do not fire it -- you must unload your rifle and remove the unknown components.
IMPROPER AMMUNITION DESTROYS GUNS	



WARNING—BLACK POWDER



Never Pour
Powder Directly
From Flask!

Black Powder is an extremely sensitive propellant and is readily ignited by heat, spark, static electricity, friction, pressure, impact, etc. Unlike smokeless powder, Black Powder will ignite with great violence and rapidity even when unconfined.

Black Powder should be handled only in very small quantities. Never pour powder directly from a flask or powder horn into any muzzleloading firearm! Never smoke while handling Black Powder!

Many shooters pre-weigh single charges into small containers for use on the range or in the field. Never fire the rifle near an open powder container, or an explosion may result.

If you are not familiar with safe handling procedures for Black Powder and for muzzleloading firearms in general, you should obtain one of the authoritative muzzle loaders' Manuals and study it carefully *before* beginning to shoot.

**BLACK POWDER IS
EXPLOSIVE**

PROJECTILES

The **RUGER® MODEL 77/50** is designed to use a .500" diameter pure lead round ball or lubricated conical bullet of pure lead, a .490" round ball with a lubricated .010 - .015" thick cloth patch, or a smaller diameter projectile encased in a .500" diameter sabot. Bullets of either type can be purchased from your dealer, ready to use, or can easily be cast at home with a small investment in equipment. Information on bullet casting is available from the manufacturers of moulds and casting equipment and from various authoritative handbooks. Your dealer should be able to provide you with any equipment which you may require. (See "Lead Exposure" Warning, p. 7)

The Ruger Model 77/50's rifling twist (1 turn in 28") is designed for best results with pre-lubricated soft lead conical projectiles, or jacketed or soft lead bullets encased in "sabots" (See p. 10). Patched round balls generally do not deliver as high a level of accuracy with this rifling twist, but may be safely used if correctly loaded (See p. 14).

The use of non-saboted jacketed or alloy bullets is not recommended as accuracy is generally not as satisfactory as with the pure lead bullets. They may be difficult to load and may raise pressures to dangerous levels.

Whatever projectile you select, you must remember that if it is not a tight fit in the barrel when loaded, it could shift forward off the powder charge and act as a bore obstruction, causing the barrel to bulge or burst when fired! It is your

responsibility to select the proper lead ball/patch combination of a lubricated conical lead bullet that fits securely in the bore, yet is not excessively difficult to load, particularly after a shot or two of black powder fouling has built up in the bore.

Never load multiple projectiles into the barrel. The rearmost projectile slamming into the other projectiles when fired could cause a burst barrel and severe personal injury. Use only one bullet at a time.

SABOTS

Some projectiles designed for muzzleloading rifles are considerably undersized from the bore diameter and are encircled by a resilient synthetic or fibre “sabot” or “shoe”. An undersize sabot can easily release its projectile to become a bore obstruction, or the sabot itself can act as a bore obstruction. Never lubricate a sabot -- this can cause the sabot bullet to slip forward up the bore and act as an obstruction when fired, possibly resulting in destruction of the rifle and severe injury to the shooter or bystanders! If sabots are used, their manufacturer’s directions must be scrupulously followed.

PATCHING

.490” diameter round ball projectiles of soft lead must be fired with a lubricated round linen cloth patch of .010 - .015” thickness (about that of a gun cleaning patch) and about 1.5” diameter. However, many shooters prefer to use lubricated soft lead conical projectiles, and these often work best without a patch, particularly if they are hollow-based. Always follow the instructions regarding patches that are furnished by the manufacturer of the projectile (or bullet mold if you cast your own bullets) that you chose. The best lubricants for patches are vegetable-based greases, synthetic lubricants specifically designed for this use. Petroleum-based lubricants often char the patches when fired and may leave excess residue in the bore -- don’t use them to lubricate patches for bullets.

PERCUSSION CAPS

A percussion cap is a small metal cup, the interior top of which is coated with a priming mixture. This priming mixture is usually covered with a foil or paper liner. It fires when struck a blow.

The cap is placed on the nipple and when struck by the striker, the priming compound explodes, igniting the powder charge.

The cap should fit the nipple only tightly enough so that it does not fall off when the barrel is elevated with the bolt open. Do not attempt to use caps which are too tight or try to force or pound caps onto the nipples, as a premature discharge could result. Suggested cap size for the **RUGER® MODEL 77/50** rifle is No. 11 (U.S.) or equivalent.

Since percussion caps have an open end (which is placed on the cylinder nipple when you are ready to fire), they are susceptible to contamination. Be careful when handling percussion caps, especially with oily fingers, and try to keep water, grease, dirt and other contaminants out of the open end of the caps. Failure to do so is the main cause of misfires in percussion muzzleloading firearms.



WARNING—PERCUSSION CAPS

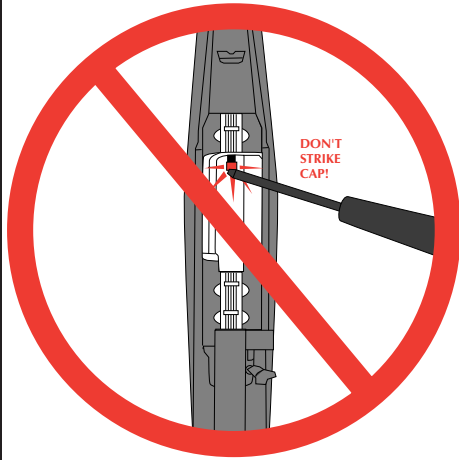

Percussion caps are designed to fire as the result of a blow (“percussion”).

A capped rifle loaded with powder and ball is fully loaded and will fire if the cap is struck.

Never clean, lubricate, disassemble, or work on a rifle while it is capped or loaded. Never install, remove, or carry a capped nipple or breech plug.

Always remove the percussion cap before unloading the barrel or disassembling the rifle.

**NEVER STRIKE A
PERCUSSION CAP**

EYE AND EAR PROTECTION

Safety glasses must be used when loading and firing the **RUGER® MODEL 77/50**, or any percussion firearm. In percussion muzzleloaders, unlike cartridge firearms, the thin percussion cap is the only seal against the hot gasses of main powder charge, which can escape out of the nipple with great force when the rifle is fired. Small pieces of the percussion cap are frequently blown away to the side or rear when a percussion arm fires. Always wear hearing protection when firing any firearm, in order to avoid permanent hearing damage.

TO LOAD AND FIRE

Practice this important aspect of gun handling (with an unloaded rifle) until you can perform each of the steps – described below – with skill and confidence. But before loading the rifle, please read completely through this manual, and be certain the muzzle is pointing in a safe direction. Do not load the rifle until you are ready to use it!

(The following procedure assumes a new rifle with the bolt out.)

INSERTING THE BOLT

1. Be certain the barrel is empty by pointing the muzzle upward towards a light source and glancing through the rear of the action at the rear end of the nipple. You should see light through the hole in the nipple, indicating that the barrel is empty. Keep the muzzle pointed in a safe direction, and keep your fingers off the trigger throughout the assembly and loading process until you are actually ready to fire. (See Rule 2, p. 43).
2. Position the safety selector in the “Load-Unload” position (see Figure 3, p. 6).
3. Make certain the bolt is correctly assembled and ready to be inserted in the receiver. If there is any doubt, see numbered paragraph 6, p. 33 (To Assemble the Bolt) in the “Reassembly” section of this manual.
4. Note that if the breech plug is not screwed all the way into the receiver, the bolt cannot be fully closed. Whenever you install the breech plug, be sure that you coat its threads with grease in order to be able to remove it for cleaning. (See p. 31).
5. Depress the bolt-stop and insert the bolt into the receiver.

LOADING



WARNING: Please re-read carefully the paragraph entitled “Warning - Black Powder”, p. 9.

In the interests of both performance and safety, it is important that steps which follow be performed in sequence and with attention to detail:

1. BEFORE LOADING:

Lift the bolt handle and place the safety in the “load-unload” position. Remove the bolt by pressing down on the bolt stop and withdrawing the bolt to the rear. Look through the hole in the nipple with the barrel pointed toward a light source to **make sure the barrel is empty of powder or ball**. Reinsert the bolt.

Check rifle to ensure that:

- A. Nipple is uncapped.
 - B. Barrel is empty.
 - C. Bore and nipples are free of grease, oil or other obstruction.
- ### 2. CLEARING THE NIPPLES:

Without loading the barrel, place a percussion cap on the nipple. **Point the rifle in a safe direction**, a few inches from some grass, leaves, or snow. Move the safety to the full forward “fire” position, and pull the trigger to fire the cap. You should see the grass, leaves, or snow move from the force of the percussion cap. Repeat this process with a second cap. This is done to ensure that the nipple passage is clear and dry.

Open the bolt, place the safety in the “load-unload” position and remove the percussion cap and cap fragments.



WARNING – LOADING



Know the bore diameter of your rifle you are loading and load projectiles of only correct diameter into it! Either a too tight or too loose projectile can cause a burst barrel, resulting in serious injury to the shooter or bystanders.

This rifle is designed to use a .500" projectile (or a .490" projectile with a .010 - .015" thick patch), a #11 percussion cap, and up to a maximum of 120 grains of FFG black powder (or equivalent volume of Pyrodex RS) only. Never use smokeless powder of any kind.

Before firing, be certain the percussion cap is seated completely on the nipple. A rifle discharged by the closing of the bolt on an incorrectly seated cap can result in possible serious injury to the shooter and those nearby.

If a projectile does not fully seat readily, do not force it. Check to be certain that each projectile is the proper caliber and of correct dimensions. If you cannot determine why the projectile will not fit, carefully remove the projectile, empty the rifle of all powder (see pp. 20 - 22) and write or call the factory.

The wrong components or an excessive powder charge can destroy your gun and result in serious injury to you or bystanders.



**BE SURE WHAT YOU LOAD
IS CORRECT**

3. CHARGING THE BARREL:

- A. Starting with the bolt open in its full rearward position, place safety in the "load-unload" position. (See Fig. 5) Do not touch the trigger while loading! **Be sure that no cap is on the nipple!**
- B. With one hand, hold the rifle securely with the barrel pointing straight upwards and the recoil pad or butt plate on the ground. **Keep your face and other body parts away from the muzzle!**

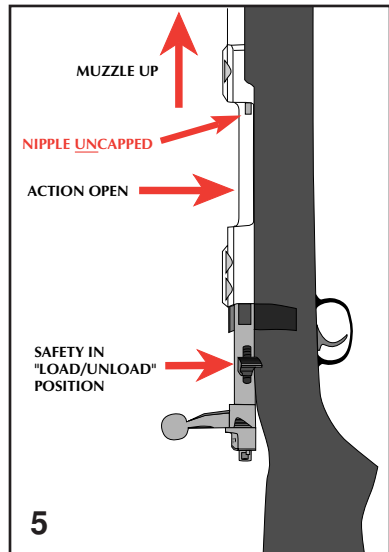

LOADING POSITION

- C. Using a dipper or other single-charge measure, pour the desired amount of powder into the front opening (muzzle) of the barrel. (See Fig. 6) Never exceed the powder charge recommended for the projectile you have selected from a reputable black powder loading manual. **Do not pour powder directly from the flask or other powder container** (See “Black Powder Warning”, p. 9)

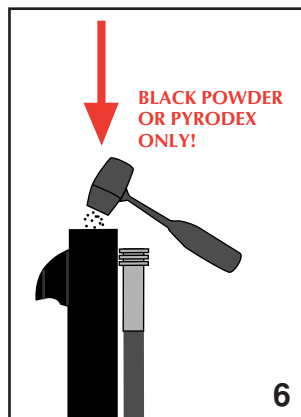

LOADING POWDER

- D. Place the bullet in the muzzle of the charged barrel, with the flat spot (“sprue”) of the round ball or the point of a lubricated conical projectile facing upward, out of the muzzle. (See Fig. 7) If you lubricate your projectile, be sure to use a lubricant designed specifically for black powder. Ordinary petroleum-based lubricants can cause fouling to build up and make it difficult to fully seat the projectile on the powder charge, with the resulting danger of a burst barrel and injury to the shooter and bystanders.

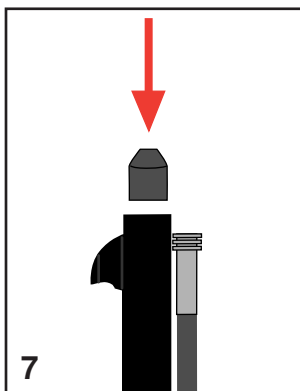

INSERTING CONICAL PROJECTILE

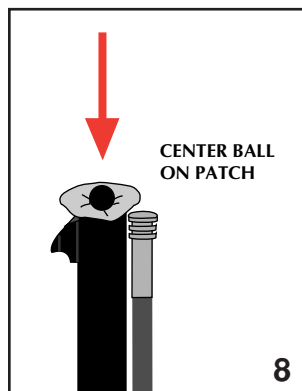

INSERTING PATCHED BALL

- E. If you wish to use a patch on your round ball for tighter fit or improved sealing of the ball in the barrel, place a 1 1/2" diameter patch lubricated with a commercial black powder gun grease centered over the muzzle before you place a ball into the muzzle. (See Fig. 8) Again, align the sprue of the bullet in the center of the bore facing upward, out of the muzzle. (See Fig. 9, p.15) Some shooters now push the ball slightly into the muzzle with a “short starter” rod of about 1” in length and then trim away any excess patch material protruding from the muzzle, but this is optional.

- F. Remove the ramrod from under the barrel by pulling it downward out of its recess in the barrel and then forward (upward) out of the stock and ramrod thimble. Grasp the ramrod around its side and, with a firm even stroke, seat the bullet firmly on the powder charge. **Do not push down on the ramrod tip with the palm of your hand, in the event that the powder charge ignites while you are loading!** (See Fig. 10) For maximum accuracy, the powder charge should be very lightly compressed by the bullet. Be sure that the bullet is seated deeply enough so that it rests firmly against the powder charge. **Do not leave an air space between the powder and the bullet. This can cause the barrel to burst when firing!**

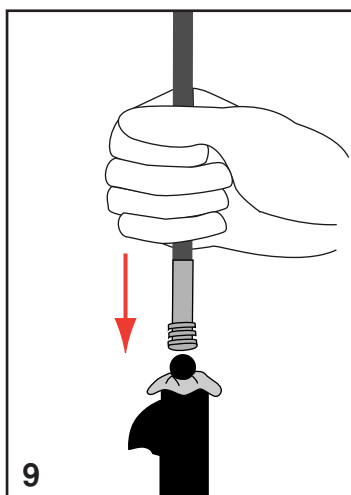

9 STARTING PROJECTILE

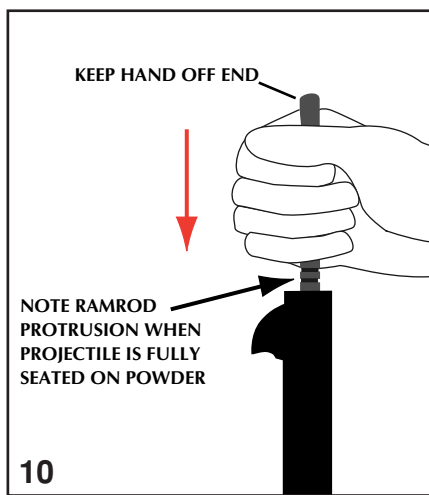

10 FULLY SEAT PROJECTILE

- G. You should not “pound” on the ramrod to fully seat the projectile, since this can deform the bullet, cause accuracy problems, or even set off the powder charge and fire the rifle! Once you determine that you have fully seated the projectile of your choice onto the correct powder charge, note and mark how much of the ramrod protrudes from the muzzle. You should always be sure that no more of the ramrod protrudes after loading the rifle -- otherwise, you may have loaded too much powder, multiple projectiles, or failed to have fully seated the ball onto the powder charge. Firing a rifle with any of these conditions can result in a wrecked rifle and injury to the shooter and bystanders. Be safe -- unload your rifle and start over again if your ramrod protrudes excessively from the muzzle after loading (See “To Unload”, p. 20)
- H. **REMOVE THE RAMROD FROM THE BARREL.** If you replace it in the thimble under the barrel, you will not leave it behind.

IF YOU FORGET TO LOAD POWDER

If you have inadvertently loaded a ball without first loading a powder charge, you must remove the breech plug with the breech plug wrench and push the ball from the barrel (See “To Unload”, p. 20) before starting all over again.

4. CAPPING THE NIPPLE:

Remember that the safest way to carry any loaded muzzleloading rifle is uncapped. Cap it only just before you are immediately ready to fire. See “Handling Warning”, p. 17.

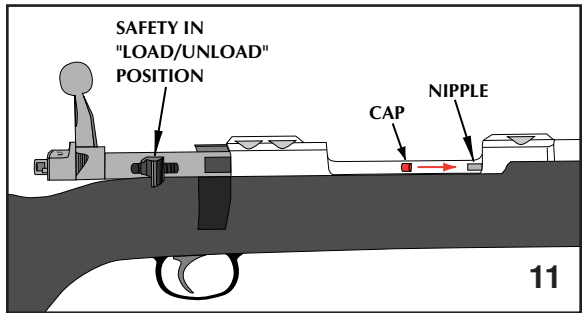

CAPPING THE NIPPLE

Be sure you use only #11 percussion caps of good quality and correct size. With the bolt open, carefully place a #11 cap on to the nipple. An inline capper, sold commercially, is preferred by some shooters. It is not required, but is especially helpful if a scope is mounted on the rifle. Do not put oil, grease, or dirt into the open end of the cap while loading -- misfires could result. The caps should be completely seated on the nipple without undue pressure. Caps should only be tight enough so that they do not fall off the nipple when the barrel is elevated with the bolt open. (See Fig. 11)



WARNING: *It is dangerous to attempt to use caps which are too small. Never force a cap on to the nipple. Since caps fire by percussion, excess force or a blow in seating them can cause the caps to discharge, firing the gun and forcing hot gas out of the nipple, which can cause injury.*

5. PREPARING TO FIRE:

To normally fire the rifle, the bolt must first be closed after the nipple is capped. This is done by pushing the bolt handle fully forward, and lowering it. **DO NOT TOUCH THE TRIGGER WHILE OPERATING THE BOLT. KEEP THE SAFETY IN THE “LOAD-UNLOAD” POSITION WHILE OPERATING THE BOLT, AND MOVE IT FULLY REARWARD TO THE “SAFE” POSITION AS SOON AS THE BOLT IS CLOSED. TOUCH THE TRIGGER ONLY WHEN YOU ARE READY TO FIRE AND HAVE DISENGAGED THE SAFETY WHILE AIMING AT A TARGET.**

6. FIRING:

Once the safety is pushed fully forward to the “fire” position, the RUGER MODEL 77/50 is now ready to fire. Light pressure on the trigger will cause the striker to fall forward, striking the percussion cap, and the rifle will fire. **Always be certain that you know where the bullet will strike when you fire the rifle.**



WARNING: DO NOT TOUCH THE TRIGGER UNTIL YOU ARE ACTUALLY READY TO FIRE THE RIFLE.

Never allow the thumb to touch the cocking piece as it can be pinched when the striker moves forward during firing.



WARNING – HANDLING

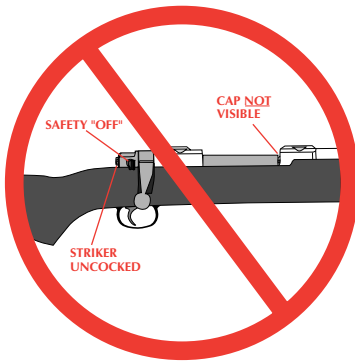

If this rifle is to be carried loaded, certain precautions must be observed in the interest of safety. It is safest to carry any muzzleloader with no percussion cap on the nipple. **The gun should never be carried with the striker resting on a percussion cap. Under such circumstances, a light accidental blow to the striker can readily cause the gun to discharge.**

Never cap the nipple until you are ready to shoot the rifle. When capping, be sure that the safety is in the “load-unload” position. After capping, immediately place the safety in the full-rearward “safe” position and keep it there until you are actually aiming at a target or game. **Only when you are immediately going to shoot should you move the safety fully forward to the “fire” position.**

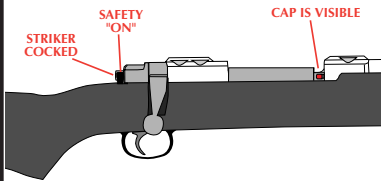

However, the safety is a mechanical device and any mechanical device can fail. Never depend upon this or any other mechanical device to justify careless handling of any firearm. **Keep the firearm pointed in a safe direction at all times.**

**NEVER PUT THE STRIKER
DOWN ON A CAPPED
NIPPLE**



WARNING – FIRING

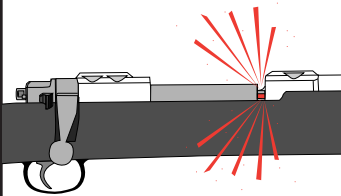

When firing any rifle, be sure all persons are a safe distance to the rear of the shooter. When fired, all muzzle loaders discharge gas and particles through the clearance gap between the striker and the rear of the nipple. These particles of powder grains and percussion cap fragments are projected broadly sideways at high speed and can injure a person who is standing too close to the rifle. When firing any muzzle loader, always be certain that nothing – including either of your hands – is in the path of the hot gas and particles which are discharged from the top, front and sides of the rifle. Small pieces of the percussion cap are frequently blown away when a percussion arm fires. Safety glasses *must* be used by shooters and bystanders when loading and firing any percussion firearm. Always wear hearing protection when firing any firearm, in order to avoid permanent hearing damage.



**HOT GASES EXIT
NIPPLE AREA**

Remember - Never lower the striker fully down onto a percussion cap or loaded rifle! See “Handling Warning”, p 17.



WARNING: REMEMBER THAT EACH TIME A SHOT IS FIRED, **THE SAFETY SELECTOR IS IN THE “FIRE” POSITION.** WHEN YOU OPEN THE BOLT, MOVE THE SAFETY SELECTOR TO THE “LOAD-UNLOAD” POSITION BEFORE CLOSING THE ACTION. ONCE THE ACTION IS CLOSED, MOVE THE SAFETY FULLY BACK TO THE “SAFE” POSITION.



WARNING – RELOADING



Black powder is extremely sensitive and a powder charge poured down the barrel after firing a shot can readily be ignited by an ember of partially burned powder or glowing patch fragment in the bore. Pushing a projectile down onto a powder charge can “fan” an ember into igniting the powder charge and firing the rifle.

Always wait one minute before reloading. You should wipe the bore with a cleaning patch soaked in solvent between shots.

If a cap fires but the powder charge does not, the powder may be smoldering and could ignite at any time. Wait at least one minute before attempting to recap. Remember that hot gasses can escape from the nipple if the powder charge ignites when the bolt is open, and these gasses can burn you. Keep the rifle pointed in a safe direction at all times.

Keep your head, face, eyes and hands away from the muzzle while reloading and always wear eye and hearing protection. Hold the ramrod around its sides -- never place your hand over the end of the ramrod so that it would injure your hand if the powder charge goes off (propelling the ramrod out) while reloading.

DON'T LOAD IN A HURRY

7. RELOADING:

After firing, the striker will remain down. Raise the bolt handle, put the safety in “load/unload”, and draw the bolt to the rear in a firm, smooth stroke. This will expose the nipple so you can remove the fired cap fragments. Fragments clinging to the nipple may be removed with the fingers, and fragments clinging to the bolt can be dislodged by fully pulling the bolt back smartly against the bolt stop. To fire subsequent shots, repeat all preceding steps 3 - 6, above. It is not necessary to fire a cap in between shots to clear the nipple, but you should be sure that the nipple is clear before reloading. A thin wire or similar tool works well for this.

Best results are obtained by cleaning the bore after each shot, before reloading. Soak a patch in black powder solvent or bore lubricant, place it over the front end of the ramrod, push it completely into the bore, and pull it completely out of the muzzle. If it is difficult to remove, push the patch back down and then up until it can be removed. This “swabbing” after each shot makes reloading much easier. **Never try to reload another projectile if it is excessively difficult to push down the barrel -- you may not fully seat it on the powder charge and it may act as a bore obstruction, resulting in a burst barrel and possible serious injury to the shooter or bystanders.** Instead, open the bolt, pull the projectile out of the muzzle, empty out all powder, and clean the barrel thoroughly before reloading.

DRY-FIRING: Going through the actions of cocking, aiming, and pulling the trigger of an unloaded gun is known as “Dry Firing.” The Ruger Model 77/50 should not be dry-fired, as damage to the nipple may occur, which can prevent the flame from the cap from fitting on the nipple correctly, or can prevent the cap flame from igniting the powder charge.

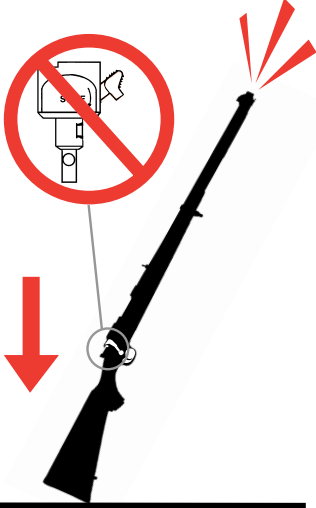
 WARNING – MISHANDLING	
	<p>Never carry the rifle loaded with the safety selector in the “FIRE” position. If dropped or struck with the safety off, the rifle may fire. Such a discharge can occur with or without the trigger being directly struck or touched. Never rest a loaded rifle against any object (wall, fence, vehicle, tree, etc.) because there is always the possibility that the rifle will be jarred or slide from its position and fall with sufficient force to discharge. Keep safety “on” unless actually firing.</p> <p>Never lower (uncock) the striker onto a percussion cap of a loaded rifle. Under such circumstances the striker will be in direct contact with the percussion cap and a light accidental blow to the striker can readily cause the gun to discharge.</p> <p>If the rifle is dropped, the bullet should be fully resealed against the powder charge, or it might act as an obstruction and cause the barrel to burst upon firing. When afield, periodically check to see if your bullet has remained fully seated on the powder charge by inserting the ramrod and pushing the projectile fully downward onto the powder.</p>
ANY GUN MAY FIRE IF DROPPED	

TO UNLOAD

(Keep rifle pointed in a safe direction)

Completely unload the rifle immediately when you are finished shooting (by removing cap, powder and ball), or fire it into a safe backstop.

It is much easier and safer to fire any muzzleloading firearm rather than attempt to unload it. However, if this is impossible, or if you are uncertain that correct components have been safely loaded, the rifle should be unloaded in accordance with the following steps.

1. Be sure the rifle is pointing in a safe direction.
2. Carefully place the safety in the "load-unload" position. (See Fig. 12) **Keep fingers away from trigger at all times during unloading!**

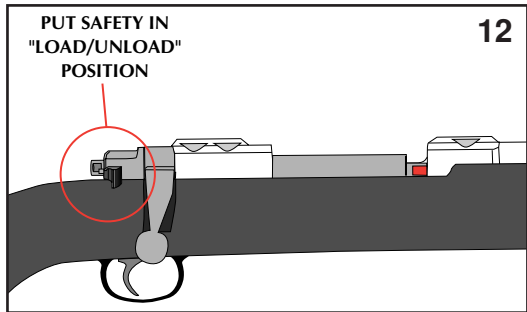

SAFETY IN "LOAD/UNLOAD"

3. Open action and carefully remove the percussion cap and any cap fragments or priming compound from the nipple. (See Fig. 13)

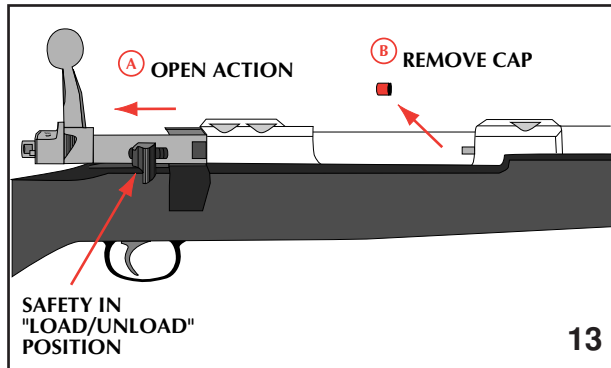

OPEN ACTION - REMOVE CAP

4. Depress bolt stop and completely remove the bolt rearward from the receiver. (See Fig. 14)

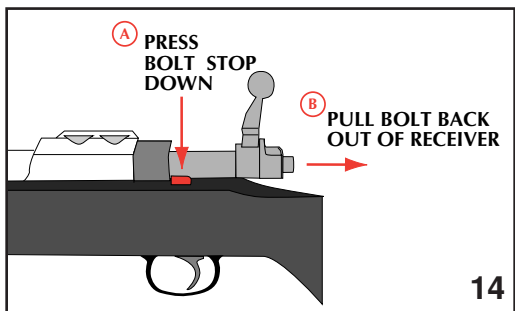

REMOVE BOLT

- Using the breech plug wrench supplied, carefully unscrew the breech plug from the chamber. Keep it in the breech plug wrench and remove it out the rear of the receiver. (See Figs. 15a & 15b)

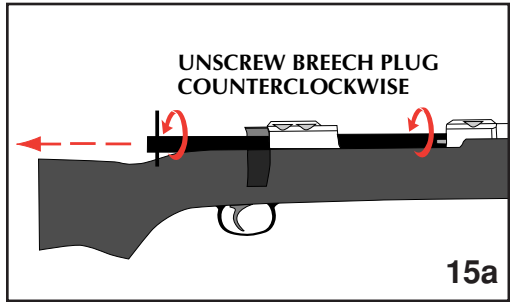

UNSCREW BREECH PLUG

- Carefully* elevate the muzzle and dump the powder out of the rear of the barrel into a container. (See Fig. 16)

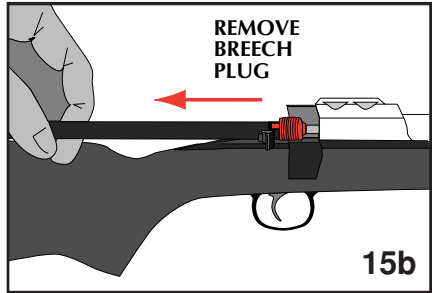

REMOVE BREECH PLUG

- Place some lubricating oil into the barrel. Now place the ramrod into the muzzle of the barrel, taking care not to damage it. Gently tap the end of the rod until the ball comes out the rear of the barrel and receiver. (See Fig. 17)

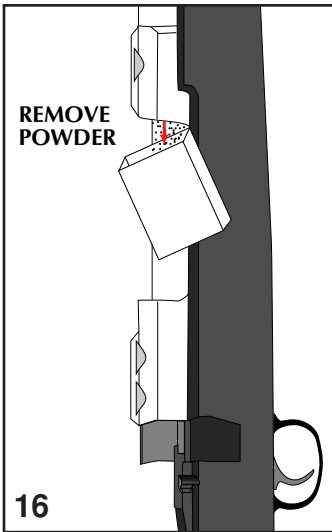

REMOVE POWDER

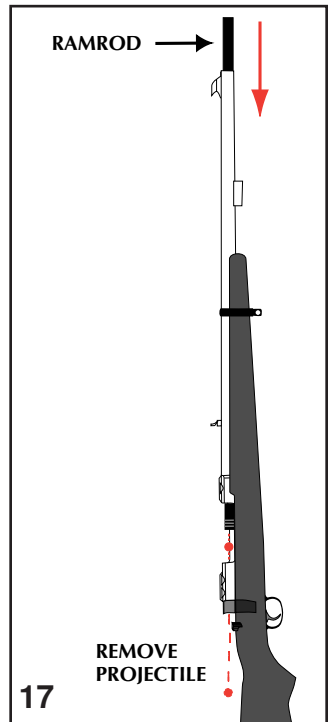

TAP OUT PROJECTILE



8. Reinsert the breech plug using the wrench.
9. Inspect the chamber to be certain the bore is completely empty of powder and ball, and that no cap or priming compound remains on the nipple.
10. Reinsert the bolt.
11. Move the safety selector to the "Fire" position and *with the rifle pointed in a safe direction*, pull the trigger as you close the bolt and ease the bolt handle downward. This uncocks the striker. "Dry Firing" is not advisable in the **RUGER® 77/50** due to possible nipple damage. *Never uncock the striker onto a percussion cap!* (See "Handling Warning", p. 17).
12. Once you know the rifle is completely unloaded and reassembled, run the ramrod fully into the barrel and note how much of it protrudes from the muzzle. *If any more of the ramrod ever protrudes from the muzzle at any time you run the ramrod fully into the barrel, you must assume that the rifle is loaded -- be careful!*

BASIC DISASSEMBLY AND REASSEMBLY

The user of a **RUGER® 77/50** should carefully read all disassembly directions and study all the illustrations and the Parts List in this manual before attempting to take the gun apart. Know the names and location of the parts before removing any of them. Although the rifle mechanism is composed of only a few parts, it is essential that the disassembly and reassembly operations be carried out with knowledge and care.

Only a few tools are required: A screwdriver or two to remove the trigger guard screws and to remove the barrel band screw, and the supplied breech plug wrench to unscrew the breech plug.

The tip of the screwdriver blade should perfectly fit the screw slots. A tip too large will scrape away metal, while too small a tip will damage the screw slots.

 WARNING – DISASSEMBLY	
	<p><i>Never clean, lubricate, disassemble or work on a rifle while it is loaded or capped.</i> Never install or remove a capped nipple. A capped nipple can discharge the rifle if struck. Always unload any firearm before cleaning, lubrication, disassembly, or assembly. Read instructions before disassembling gun.</p>
UNLOAD BEFORE CLEANING OR DISASSEMBLING	

Before taking the gun apart, set up to do it properly. Cover the work surface with a soft cloth so that the gun finish (and sights) will not be damaged, and provide a tray into which the parts can be put as they are removed from the gun.

It is preferable to carry out these procedures on a workbench or table which has a covered top. A piece of shallow nap rug or an old, coarse blanket is an ideal covering. Such a covering not only reduces the chances of the rifle slipping and being scratched, but it serves also to trap pins, plungers and springs that may otherwise get lost. It is advisable to have a container – such as a shoebox – in which each part can be placed as it is removed from the gun.

Before attempting to disassemble the rifle for the first time, study the parts drawing and parts list so as to be familiar with the relative position, appearance and name of each part. Carry out the disassembly slowly, and carefully note the position of the part in the gun before starting to remove it. If a part is under spring tension (such as, the Safety Selector, Bolt Stop, Trigger) remove it cautiously and anticipate the direction the spring and plunger are most likely to “jump.”

WARNING: If a spring or plunger become lost, do not use a substitute. Springs of correct tension are vital to the safe and reliable performance of firearms. See “Ordering Parts”, p. 39. Before starting disassembly, remove the sling, scope and rings and place the rear sight blade in its down flat position.

DISASSEMBLY

(Rifle Must Be Unloaded Prior To Disassembly)

- 1. Keep the rifle pointed in a safe direction! Put the safety in the “load-unload” position.**
- 2. OPEN THE BOLT AND CHECK TO BE CERTAIN THAT THE RIFLE IS UNCAPPED AND UNLOADED.** Run the ramrod completely down the barrel to make sure the rifle has no bullet or powder in the barrel.
- 3. TO REMOVE BOLT:** Lift the bolt handle up. Depress the bolt stop on the left side of the receiver. Remove the bolt from the rifle. (Before starting bolt disassembly, study Figure 21).
- 4. TO DISASSEMBLE THE BOLT:**
 - While holding the bolt, rotate the bolt sleeve clockwise (as viewed from the rear of the rifle) to position shown in Figure 18, p. 24. The bolt sleeve should be in the same position it is in when taken out of the receiver, but the bolt sleeve may need to be rotated clockwise until the disassembly hole is fully exposed.

b. Insert the small end of breech plug wrench handle (or suitable nail) into the “disassembly hole” in the striker/cocking piece assembly to hold it in the rear position (Figure 19). NOTE: The pin should be as close as possible in size to the hole diameter, and at least 2 inches long so that it can be used to ‘lever’ the cocking piece to the rear when reassembling the bolt stop assembly into the bolt. **Do not use a soft paper clip, etc.** Note that if you use the breech plug handle as the bolt disassembly pin, you will be unable to use the breech plug wrench to remove the breech plug until you reassemble the bolt.

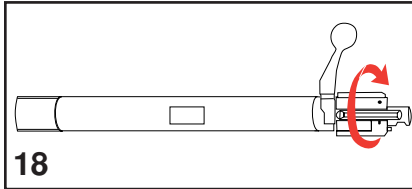

18
ROTATE BOLT SLEEVE

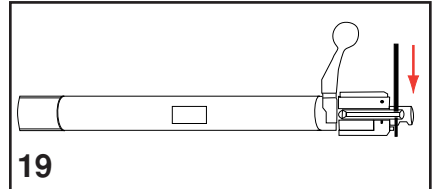

19
INSERT PIN

c. Unscrew the bolt sleeve counterclockwise (Figure 20).

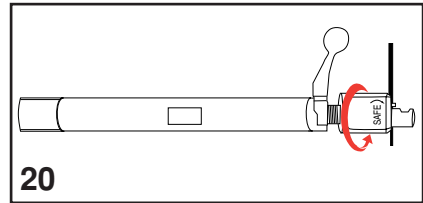

20
UNSCREW BOLT SLEEVE

d. Remove the bolt sleeve assembly. (Figure 21).

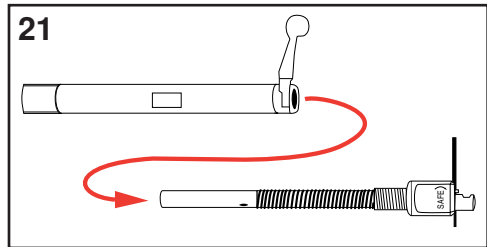

21
REMOVE BOLT SLEEVE/STRIKER ASSEMBLY



CAUTION: The bolt sleeve assembly is intended to be a permanent assembly and should not be disassembled. The parts are under great spring pressure and if disassembled could fly apart with sufficient force to cause serious injury. Also, special tools are required to correctly reassemble this part.

5. TO REMOVE THE BREECH PLUG:

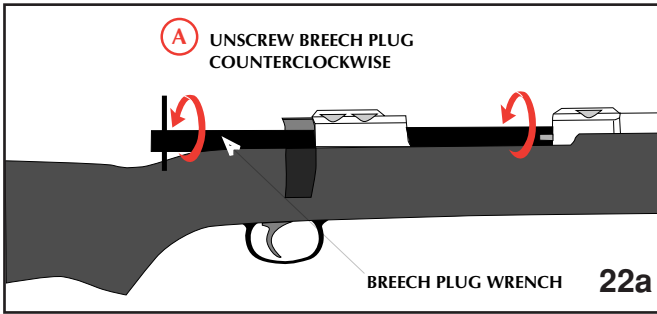

UNSCREW BREECH PLUG

a. Using the supplied breech plug wrench and handle, carefully unscrew (counter-clockwise) and remove the breech plug/nipple assembly from the rear end of the barrel. (See Figures 22a & 22b) It is easier to remove the breech plug from the receiver if you keep it in the breech plug wrench as shown.

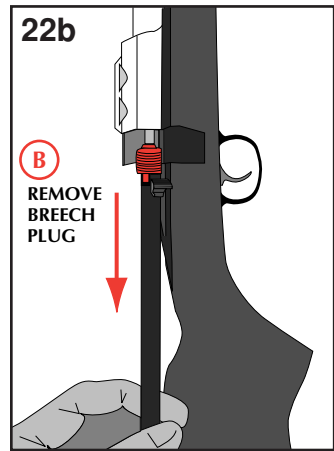

REMOVE BREECH PLUG

6. TO REMOVE THE STOCK: (Be certain the bolt has been removed from the rifle.)

a. Remove ramrod from stock. Unscrew barrel band screw and remove barrel band forward off the stock and barrel. (See Fig. 23)

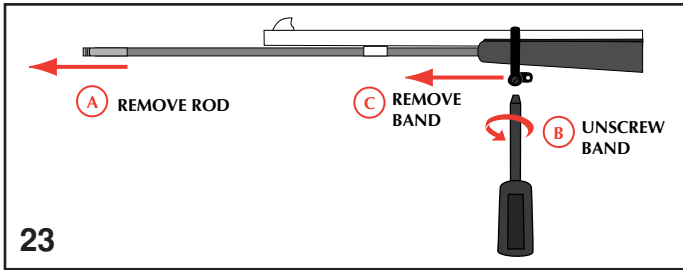

REMOVE RAMROD AND BARREL BAND

b. Unscrew and remove the two screws in the trigger guard counterclockwise and carefully remove trigger guard. (See Fig. 24) Note that the longer screw goes in the rear hole of the trigger guard.

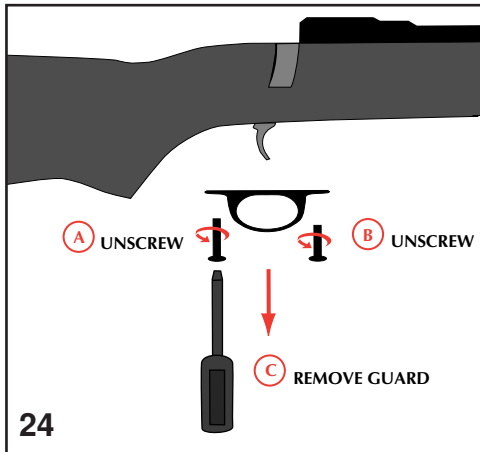

REMOVE TRIGGER GUARD

c. VERY CAREFULLY lift the barrel/receiver assembly from the stock. (See Fig. 25)

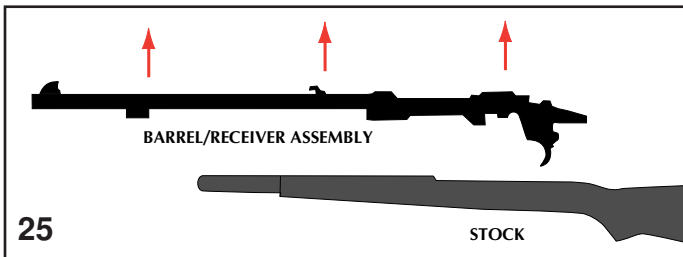

SEPARATE BARREL/RECEIVER FROM STOCK

THIS IS AS FAR AS YOU NEED TO DISASSEMBLE THE RIFLE FOR ROUTINE CLEANING AND MAINTENANCE. SEE P. 30 FOR “REASSEMBLY” INSTRUCTIONS. DETAILED DISASSEMBLY INSTRUCTIONS FOLLOW FOR FURTHER DISASSEMBLY ONLY WHEN REQUIRED IN CASES OF HEAVY FOULING, IMMERSION IN SALT WATER, ETC.

DETAILED DISASSEMBLY

1. To remove the trigger: (Safety Selector should be in the “Fire” position).
 - a. While holding the trigger in place, press out the trigger pivot pin. (Caution: Trigger is spring loaded and under tension --- be careful!).
 - b. Remove the trigger and trigger/sear spring.
2. To remove the bolt stop and sear:
 - a. Press out the sear/bolt stop pivot pin.
 - b. Remove the bolt stop and bolt stop spring.
 - c. Turn receiver upside down and slide sear forward. Sear will drop out of the top slot in the receiver.
3. To remove safety assembly:
 - a. Rotate the safety selector so that the upper section is positioned fully over the center of the receiver tang.
 - b. While holding the safety selector in place with thumb and forefinger, slide the retainer up out of receiver. (Caution: Safety Selector is under spring tension from a spring and plunger acting against the lower section of the safety selector. The spring and plunger will jump out if not contained).
 - c. Lift out the safety selector.
 - d. Remove the safety selector detent and safety selector detent spring.

See page 30 for “Reassembly” instructions.

CARE AND CLEANING



WARNING: ALWAYS BE CERTAIN THE RIFLE IS COMPLETELY UNLOADED BEFORE CLEANING. REMOVE CAP, POWDER, AND PROJECTILE.

BLACK POWDER FOULING

The chemical compounds formed by Black Powder and Pyrodex residue and certain percussion caps are extremely corrosive; rusting will begin within a very few hours after firing, if the rifle is left uncleaned under some conditions of humidity. Fouling will also slow down or “bind up” moving parts, possibly resulting in misfires (failure to fire), and “hangfires” (firing delayed up to a few seconds). It is, therefore, important that your **RUGER® MODEL 77/50** be cleaned thoroughly and without delay after each use. Furthermore, Black Powder fouling promptly hardens with the passage of time making disassembly difficult, and this fouling is extremely corrosive, even to stainless steel.

A firearm must be free of rust, dirt, grease and firing residues to function safely and reliably. Periodic maintenance, which includes inspection of components to determine if they are in proper working order, is absolutely essential.

Firing deposits particles of bullet lubricant and powder in the bore, chamber, bolt, receiver, and other parts of the rifle. There is no fixed rule as to how frequently the cleaning should be carried out, but the alert gun owner soon learns that any firearm functions most reliably and accurately when it is free of accumulations of grease and other firing residues.

Basic cleaning equipment includes: A correct size cleaning rod equipped with bore brushes (fiber and brass) and a tip in which a cloth patch can be inserted, patches, powder solvent, lubricant, small lint-free cloths and a toothbrush. Use correct size patches and brushes. Larger sizes will bind in the bore and can be very difficult to remove!

Timely attention to the simple procedures which follow will help ensure that your rifle remains in top condition for years of use:

1. *Be sure rifle is unloaded!*
2. Remove bolt from receiver. (See p. 20)
It is not necessary to remove the stock for cleaning, but removal may help prevent damage to the stock from the breech plug wrench handle, etc. Removal also makes it easier to clean the trigger and safety mechanism.
3. Disassemble bolt according to instructions on pp. 23 & 24. Then, place bolt components (except for mainspring which should not be gotten wet) in pan filled with very hot water and soap solution to soak.
4. Unscrew and remove breech plug from inside receiver. It may be necessary to tap the breech plug wrench handle with a soft mallet to loosen the breech plug, especially after repeated firing. Screw in cleaning tube to prevent cleaning solution from entering receiver and stock of rifle.

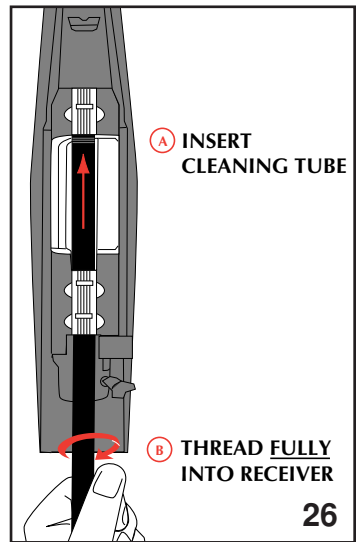



**INSERTING
CLEANING TUBE**

5. With muzzle pointed down so that water cannot enter the trigger mechanism, flush the barrel with warm water, until water runs clear from the muzzle. A cleaning patch wetted with hot, soapy water or an ammonia-based window cleaner will also work.
6. Using a bristle or brass brush wetted with soap and water solution, thoroughly scrub bore to remove all traces of fouling. Then, flush bore again with very hot water. *Do not permit water to enter the trigger mechanism.* Remove cleaning tube and carefully scrub receiver breech plug threads clean. Clean the trigger mechanism thoroughly with a brush wetted with a commercial black powder solvent. Dry bore and receiver assembly thoroughly with clean cloth and set aside.

7. Thoroughly scrub bolt component parts in pan, flush with very hot water, or ammonia-based window cleaner, rinse and then wipe dry. Scrub the front of the bolt face with a toothbrush to remove all traces of powder and cap fouling.
8. Soak the breech plug in very hot, soapy water or an ammonia-based window cleaner. Scrub its threads with a toothbrush. Thoroughly dry the breech plug, making sure the flash hole through the nipple is clean and dry.
9. Inspect all parts (including bolt, barrel, receiver, trigger, etc.) to be sure that these are clean and dry. Pay particular attention to the breech plug threads inside the barrel.
10. Oil the bore and all parts thoroughly with a good quality gun oil, then reassemble. However, avoid lubricating the striker, striker spring, or the inside of the bolt, to avoid oil spattering when firing or sluggish ignition in cold weather. Remember to lubricate the breech plug/nipple assembly threads with a good quality black powder gun grease prior to reassembly (See page 30).
11. The outside (exposed) metal parts should be wiped down and lightly oiled to remove fouling and prevent rusting.

NOTE: Several firms offer Black Powder solvents and these may be used in place of the soap and hot water solution. However, not all smokeless powder solvents will render the fouling left by Black Powder non-corrosive. Be sure you use a solvent specifically intended for black powder fouling, hot, soapy water, or an ammonia-based window cleaner, followed by a good gun oil.

Sometimes, lead build-up can occur in the barrel throat at the muzzle of the barrel, and in the bore. If 'leading' is noted in your rifle, clean it out before it builds up and interferes with reliable functioning and accuracy. A special 'lead removing' cleaning tool (for bore and chamber) is available from gun stores.

 WARNING – LUBRICATION	
	Firing a rifle with oil, grease, a bullet, or any other material even partially obstructing the bore may result in damage to the rifle and serious injury to the shooter and those nearby. Do not spray or apply lubricants directly on black powder. If the powder charge is affected by the lubricant, it may not be ignited, but the energy from the percussion cap may be sufficient to push the bullet into the bore where it may become lodged. Firing the obstructed bore may damage the rifle and cause serious injury or death to the shooter and those nearby. In the event of a misfire, always reseal the bullet fully onto the powder charge before re-capping. Use lubricants properly. You are responsible for the proper care and maintenance of your firearm.
IMPROPER LUBRICATION DESTROYS GUNS	

The rifle's internal mechanism can be lubricated without disassembly. A very few drops of light oil recommended as suitable for firearms, applied periodically about the various frame openings, will work its way into the mechanism parts. The exterior of the rifle should be cleaned with a solvent and then wiped with an oily cloth.

Do not keep a rifle in a leather, fabric or canvas case or scabbard when it is stored. These materials attract moisture, even though they may appear to be dry.

12. **Never store a loaded gun!**

 WARNING – STORAGE	
	<p>Never place or store any firearm in such a manner that it may be dislodged. Firearms should always be stored securely and unloaded, away from children and careless adults.</p>
STORE SECURELY & UNLOADED	

REASSEMBLY
(Again, Be Sure Rifle Is Unloaded)

1. To replace the safety assembly:

- Place the safety selector detent and safety selector detent spring into the hole in the receiver.
- Set the safety selector in place with its upper section positioned over the center of the receiver tang.
- While holding the safety selector in place with thumb and forefinger, slide the safety selector retainer into dovetail from the top. Align the notch in the safety selector retainer with the sear pivot pin hole.

2. To replace the bolt stop and sear:

- Replace the bolt stop and bolt stop spring. Partially insert sear/bolt stop pin through bolt stop, spring and receiver (flush with sear slot).
- Place the rear end (the end with the hole in it) of the sear into the slot from the top of the receiver. Swing the rear end of the sear up and slide the sear into position until the hole in the sear is aligned with the mating holes in the receiver.
- Press in sear/bolt stop pin until head of pin stops against bolt stop.

3. To replace the trigger:

- a. Rotate safety to “fire” position.
- b. Place the trigger/sear spring over the dimple in the trigger.
- c. Assemble the trigger while aligning the spring with the dimple on the sear.
- d. While holding the trigger in position, replace the trigger pivot pin.

4. To replace the breech plug:

- a. Lubricate the breech plug/nipple assembly threads thoroughly with a good quality black powder gun grease. (See Figure 27) Do not lubricate the back or nipple portions of the breech plug. Failure to lubricate it will make this part extremely difficult to remove.

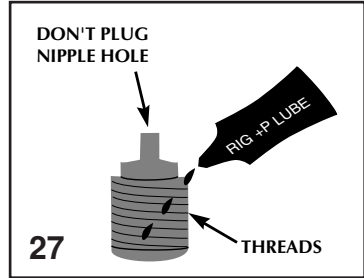

**ALWAYS LUBRICATE
BREECH PLUG!**

- b. Using the supplied breech plug wrench, insert and tighten the breech plug/nipple assembly into the threaded rear end of the barrel. (See Figure 28) Do not over-tighten -- firmly snug will do. It will tighten during firing.

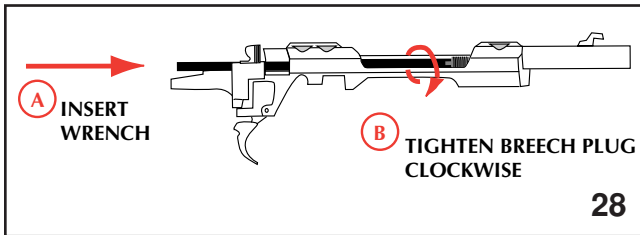

REPLACING THE BREECH PLUG

5. To replace the barrel/receiver assembly into the stock: (Caution: Be certain that the pivot pins are not protruding from either side of the receiver.)
- Carefully install the barrel/receiver assembly into the stock, making sure the barrel/receiver assembly is in the most rearward position.
(See Figure 29)

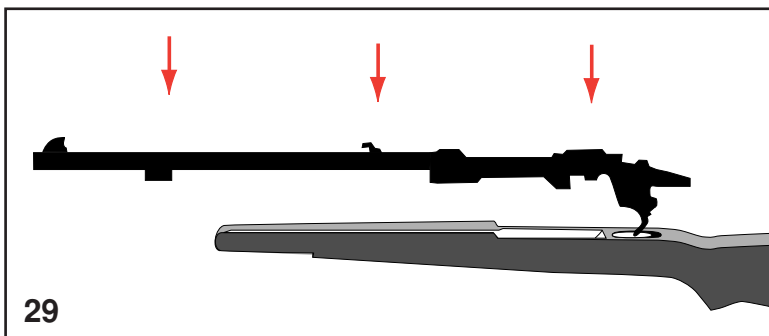

INSERT BARRELLED ACTION INTO STOCK

- Install the trigger guard and screws (shorter screw in front).
(See Figure 30)

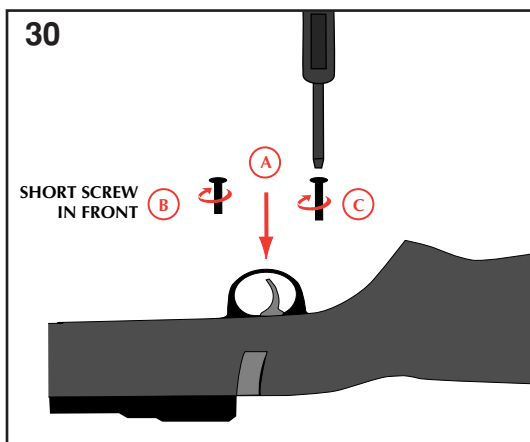

REINSTALL TRIGGER GUARD

c. Slide barrel band over barrel and rearward onto the stock forend. Tighten band screw when in place. Replace ramrod in stock through thimble under barrel. (See Figures 31a, 31b, & 31c) Ramrod head should rest in barrel cut beneath muzzle. Ramrod will not enter stock easily if band screw is tightened excessively.

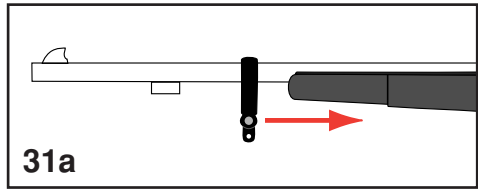

31a
REINSTALL BAND

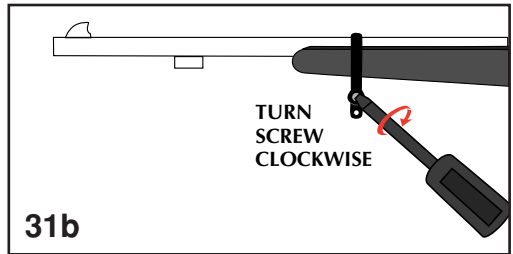

31b
TIGHTEN BARREL BAND SCREW

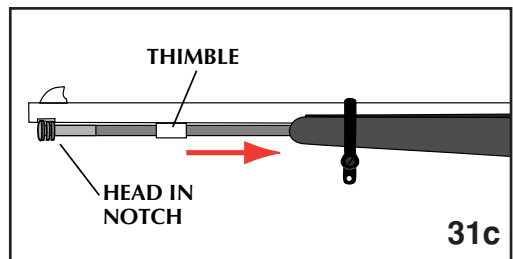

31c
REINSTALL RAMROD

6. To assemble the bolt:

a. Lubricate the bolt sleeve threads and the angled cocking cam surface on the rear of the bolt. Slide the bolt sleeve assembly into the bolt from the rear. Screw the bolt sleeve into the bolt to position shown (clockwise past notch). (See Fig. 32)

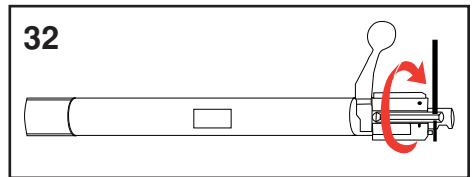

32
SCREW BOLT SLEEVE INTO BOLT

b. Carefully remove the wrench handle on pin from cocking piece (See Fig. 33)

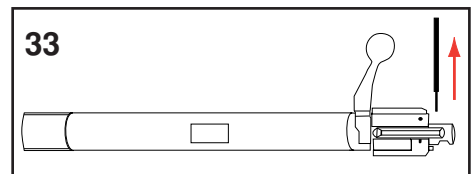

33
REMOVE PIN

c. Carefully rotate counterclockwise until cocking piece snaps into small notch and ***no further!*** Only when the bolt is correctly assembled should it be inserted into the receiver. (See Fig. 34)

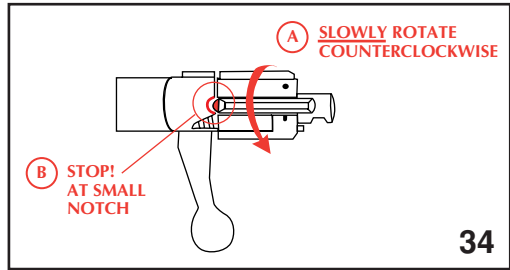

FINAL BOLT ASSEMBLY

d. With safety in “load/unload” (middle) position, insert the bolt into the receiver. (See Fig. 35)

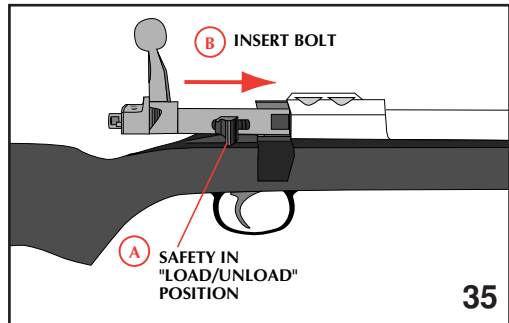



REINSERT BOLT

REGARDING ACCURACY

The accuracy of any muzzleloading rifle can vary depending upon the make and type of projectiles and powder charge used in it. Such being the case, if your **RUGER® MODEL 77/50** rifle does not perform to expectations, it is advisable to try several brands and types of projectiles to determine which one delivers the best accuracy, before proceeding further. If your rifle is not as “accurate” as you believe it should be, before concluding that some serious fault exists, run the following checks:

1. Be certain the barrel band and the trigger guard screws are snugly tightened.
2. Be certain the bore is clean and free from accumulated fouling (deposited by black powder and lead bullets). See the “Care and Cleaning” section of this Manual, pp. 27 - 30.
3. Check the sights, or scope mounting system, for tightness, setting and alignment.
4. Try increasing or decreasing the powder charge you use, never exceeding 120 grains of powder. The heaviest charges are usually the least accurate and give the most powder fouling, making consistent shot-to-shot accuracy difficult.

If everything is tight, the bore is clean, the sights are properly aligned and secure but the accuracy problem persists, **DO NOT alter the stock bedding in any way.** Do not scrape away wood, and do not bed with “glass,” plastic, epoxy, etc. Once a rifle stock has been altered, it cannot be reworked by our Product Service Department. If you still have an accuracy problem, write a brief letter to our Product Service Department, 411 Sunapee Street, Newport, New Hampshire 03773 and describe the nature of the problem based on the use of the specific components and load you use. You will receive a prompt response from us and if indicated, detailed instructions with regard to the return of the rifle.

 WARNING – MALFUNCTIONS	
	<p>If the bolt hangs up, jams, or binds when being closed, do not attempt to force it forward by pushing or striking the bolt handle.</p> <p>Most failures to close are caused by improper capping of the nipple, a dirty receiver, cap fragments, or a breech plug not properly screwed fully into the barrel.</p> <p>Whatever the cause, the gun user must, above all, recognize that jams can result in the very potentially dangerous situation of a percussion cap discharging the powder charge before the bolt is closed. If this occurs, cap fragments and hot gasses will fly out of the gun with sufficient force to cause injury. Always wear shooting glasses and hearing protectors!</p>
	STRIKING PERCUSSION CAP WILL FIRE THE RIFLE

TO CLEAR A MALFUNCTION (“JAM”)

If the rifle becomes difficult to operate, this can usually be traced to three basic causes (followed by the appropriate corrective action):

1. Accumulated black powder fouling (cease firing & clean gun).
2. Percussion cap fragments inside receiver (carefully remove).
3. Percussion caps not fully seated on nipples (carefully reseal). Be sure you are using the correct size cap (#11).

If it becomes necessary to disassemble the rifle to clear a jam, be sure to *unload* it first. *Never* work on any gun with a percussion cap on the nipple!

MAINTENANCE OF STAINLESS STEEL COMPONENTS

Firearms and components made of stainless steel are relatively more resistant to corrosion than those of blued steel. However, in the interest of proper operation and long life of a stainless steel firearm, inspect it frequently and clean, lubricate and apply an appropriate rust preventative.

Sometimes surface discoloration occurs from perspiration or from contact with some types of gun cases. Rusting may occur as a result of the firearm being exposed to moisture, salt air or chemicals.

Minor discoloration can usually be removed by rubbing the stainless area with an abrasive ink eraser, crocus cloth, or a "metal polishing" compound. When using any of these abrasives, proceed with care and use light pressure to achieve a blending of "color" with those areas that are not discolored.

External surfaces most subject to rusting from handling, or from exposure to the elements should be cleaned and wiped dry after use or after exposure to adverse conditions. If the rifle is to be stored, coat it with a light film of oil or preservative. Where the rifle is in continuing use, and the presence of oil or grease would be objectionable, then the external surfaces can be coated (after cleaning and drying) with a paste wax formulated for use on metals. Apply the wax sparingly, allow time for it to dry hard, then buff lightly with a soft cloth. When applying the wax, take care that it does not get into the mechanism or on the functioning parts or in the bore.

ATTACHING RUGER SCOPE RINGS

Each Ruger telescope ring is a mated assembly of a top and a base. Do not mix the parts of the two ring assemblies as they are not interchangeable. On the underside of each mounting ring assembly there is an integral lug, located off center with respect to the front and back sides of the mount. The lug is nearer to the front surface. By reference to the lug, the mounting ring can be correctly assembled with the front of the ring toward the muzzle of the rifle.

1. Disassemble one ring and reassemble over the scope body between the turret and the eyepiece. Remember - the lug on the base should be on the front side of the scope.
2. Install the four top screws. Do not tighten.
3. Disassemble the other ring and install it on the forward section of the scope tube with the lug forwardly also. Install the four top screws. Again, do not tighten.
4. Assemble the rings to the receiver with the lugs engaging the recesses in the top surface of the receiver. Tighten the clamp nuts so that the rings are locked to the semicircular cuts on the sides of the receiver.
5. Rotate the scope until cross-hairs are aligned properly and slide scope to desired eye relief. Then tighten the eight top screws each a bit at a time to grip the scope body.
6. Sight in according to the directions with your scope.

7. The bottom finish of a telescopic sight mounted over the action may be damaged by hot gasses and cap fragments exiting the breech area when firing. This should not affect the scope's performance. Carefully clean all scope lenses of fouling when you clean your rifle.

PLEASE NOTE THAT SOME STATES RESTRICT TELESCOPIC SIGHTS ON MUZZLELOADERS USED FOR HUNTING -- CHECK YOUR LOCAL GAME LAWS.

SIGHT ADJUSTMENT

The folding leaf rear sight is adjustable for elevation. The slide must be moved one graduation to change the point of impact by approximately one inch at 25 yards. Shooting to determine the slide setting for 'zero' at a particular distance should be done from a bench rest and over a measured distance. Use only a small screwdriver with a blade tip that exactly fits the screw-head. Loosen the screws only slightly so the slide doesn't move too freely. Move the slide in the direction you want the point of impact of the bullet to move. When the slide is positioned at the desired height, carefully tighten both screws.

Lateral (windage) adjustment is made by "drifting" the sight base in its slot. Place a short brass rod against the sight base (and only the base) and tap the sight in the direction you wish to move the point of impact.

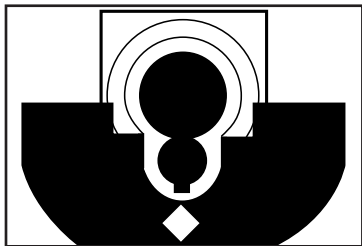

SUGGESTED SIGHT PICTURE

Top of front sight even with top of rear sight slide. Front sight centered in notch of rear sight slide. Target bull's-eye centered on top of front sight.

SERVICE AND PARTS POLICY

If you have any question with regard to the performance of your **RUGER® MODEL 77/50** rifle please write or call (603-863-3300) our Product Service Department, 411 Sunapee Street, Newport, New Hampshire 03773, fully describing all circumstances and conditions involved. If you should return your rifle to the factory for repair, or order parts for it, please comply with the following suggestions for prompt service:



WARNING: BEFORE SHIPPING ANY FIREARM, BE ABSOLUTELY CERTAIN THAT IT IS UNLOADED. DO NOT SHIP BLACK POWDER OR PERCUSSION CAPS WITH A FIREARM.

SHIPPING FIREARMS FOR REPAIR

RUGER® MODEL 77/50 rifles returned to the factory for repair should be sent to: Sturm Ruger & Company, Inc., Product Service Department, 411 Sunapee Street, Newport, New Hampshire 03773. Telephone (603) 863-3300. Guns should be sent prepaid. We will not accept collect shipments.

The Federal Gun Control Act, as well as the laws of most States and localities, do not prohibit an individual (who is not otherwise barred from purchasing or possessing a firearm) from shipping a firearm directly to the manufacturer for repair. However, before you ship your rifle to us, be certain that your State or locality does not have a law or regulation which will prohibit you from receiving the rifle from us after it has been repaired. If such receiving is prohibited, then please have a Federally Licensed firearms dealer ship the gun to us. If your rifle is sent to us by a dealer, it will be returned to him after being repaired. If a handgun (pistol or revolver) is shipped by an individual who does not hold a Federal Firearms License, it must be shipped via U.P.S. Persons who do not hold a Federal Firearms License are prohibited by Federal law from shipping a handgun by Mail. Handguns mailed in violation of the law are impounded by the Post Office.

Please do not include rifle case, sling, telescopic sights or custom accessories with a firearm being shipped to the factory for service. **DO NOT SEND GUN BOXES OR LITERATURE THAT YOU CONSIDER TO BE COLLECTOR'S ITEMS – THESE ARE INVARIABLY DAMAGED OR DESTROYED IN SHIPMENT.** Rifles and shotguns may be shipped via Parcel Post. Always insure your shipment.

Enclose a letter which includes your name, address, telephone number, serial number and model of the firearm. Describe in detail the trouble you have experienced with your firearm, or the work you wish to have done. Merely stating that the firearm "needs repair" is inadequate information.

Work performed will bear a net minimum labor charge of \$15.00 plus a \$5.00 shipping and handling charge. The charge for rebluing the Model 77/50 rifle is \$35.00 plus a \$5.00 shipping and handling charge. Custom gunsmithing service or non-standard alterations are **NOT AVAILABLE** from Ruger Product Service Departments.

 WARNING – PARTS PURCHASERS	
	It is the purchaser's responsibility to be absolutely certain that any parts ordered from the factory are correctly fitted and installed. Firearms are complicated mechanisms and IMPROPER FITTING OF PARTS MAY RESULT IN A DANGEROUS MALFUNCTION, DAMAGE TO THE FIREARM, AND SERIOUS INJURY TO THE SHOOTER AND OTHER PERSONS. The purchaser and installer of parts must accept full responsibility for the correct adjustment and functioning of the firearm after such installation.
PARTS MUST FIT CORRECTLY	

ORDERING PARTS

All parts orders for the **MODEL 77/50** rifle should be sent to: Sturm, Ruger & Co., Inc., Product Service Department, 411 Sunapee Street, Newport, New Hampshire, 03773. We cannot comply with open account or C.O.D. requests. Payment in the form of a check, money order, Visa or Mastercard must accompany your order. Credit Card orders must include the account number, expiration date and whether it is a Visa or Mastercard account. Minimum parts order is \$1.00 plus a \$3.50 shipping and handling charge. Order parts by Part Number and Part Name and include the entire serial number of the firearm for which the parts are being ordered. The price shown for parts does not include the minimum net labor charge of \$15.00 plus \$5.00 shipping and handling charge if the parts are factory fitted. All factory-fitted parts are fitted on an exchange basis only. We will not return the replaced parts.

Because the receiver of the Model 77/50 rifle (part number J00110) is a serial numbered component, it is defined as a “firearm” by Federal law and is not sold as a separate component.

*Parts designated by an asterisk must be factory fitted. These parts are fitted on an exchange basis only. We will not return the replaced parts. We will not return any part that is broken, malfunctioning, badly worn or has been modified. See “Warning — Parts Purchasers”, above.

	CAUTION: A gun containing modified, broken, malfunctioning, or badly worn parts should not be fired.
-------------------------------------------------------------------------------------	-------------------------------------------------------------------------------------------------------------

PARTS LIST AND SUGGESTED RETAIL PRICES

Design, prices and specifications subject to change without notice.

SPECIFY MODEL AND CALIBER WHEN ORDERING

RUGER® MODEL 77/50 PERCUSSION RIFLE

(See Exploded View on Page 42)

40

Part Name	Part No.	Model	Caliber		
			.50	Blued	Stainless
Accessory Kit - Includes: Cleaning Tube; Breech Plug Wrench; & Wrench Handle	J29001	All Models	•	\$ 9.75	—
* Barrel	0J8012	77/50-RS, 77/50-RSO	•	65.00	—
* Barrel	K0J8012	K77/50-RSBBZ	•	—	\$ 118.00
Barrel Band	J06801	All Models	•	6.00	—
Barrel Band Screw	B-69	All Models	•	.50	—
Bolt Handle	KJ01006	All Models	•	50.00	—
Bolt Lock Plunger	KJ02600	All Models	•	—	2.00
Bolt Lock Plunger Retainer	J04600	All Models	•	.50	—
Bolt Lock Plunger Spring	J04500	All Models	•	.50	—
Bolt Sleeve	KJ01700	All Models	•	—	18.75
Bolt Stop	J05302	77/50-RS, 77/50-RSO	•	3.75	—
Bolt Stop	KJ5302T	K77/50-RSBBZ	•	—	4.00
Bolt Stop Plunger Spring	J05401	All Models	•	.50	—
Breech Plug	KJ06705	All Models	•	—	9.50
Breech Plug Wrench	J09001	All Models	•	6.00	—
Breech Plug Wrench Handle	J09100	All Models	•	1.00	—
Butt Plate	C-63	77/50-RSO	•	2.50	—
Butt Plate Screw, 2 Req'd	B-64	77/50-RSO	•	ea. .50	—
Cleaning Tube	J09300	All Models	•	3.00	—
Cocking Piece	KJ01800	All Models	•	—	8.00
Front Trigger Guard Screw	J04705	All Models	•	.50	—
Front Sight, Assembly	J26016	All Models	•	21.50	—
Ramrod Assembly	J27105	All Models	•	16.50	—
Ramrod Support	J08406	All Models	•	21.50	—
Rear Mounting Screw	J04800	All Models	•	.50	—
Rear Sight	J06100	All Models	•	13.00	—

Receiver	J00110	All Models	•	Not Offered For Sale	
Receiver Filler Screws, 2 Req'd, Not Illustrated	C-83Black	77/50-RS, 77/50-RSO	•	ea. .50	—
Receiver Filler Screws, 2 Req'd, Not Illustrated	C-83	K77/50-RSBBZ	•	ea. .50	—
Recoil Pad	D06304	77/50-RS, K77/50-RSBBZ	•	5.00	—
Recoil Pad Screw, 2 Req'd.	D-84	77/50-RS, K77/50-RSBBZ	•	ea. .50	—
* Safety Selector	J03800	77/50-RS, 77/50-RSO	•	8.50	—
* Safety Selector	KJ03800	K77/50-RSBBZ	•	—	9.00
Safety Selector Detent	J04300	All Models	•	.50	—
Safety Selector Detent Spring	D-32	All Models	•	.50	—
Safety Selector Retainer	J02100	77/50-RS, 77/50-RSO	•	1.50	—
Safety Selector Retainer	KJ02100	K77/50-RSBBZ	•	—	2.00
Scope Ring Clamp	D-74	All Models	•	2.00	—
Scope Ring Nut	D-73	All Models	•	2.00	—
Scope Ring Screws, 8 Req'd.	D-76	All Models	•	ea. .50	—
Scope Rings (Medium Rings)	S-100RH	All Models	•	40.60	45.40
Accommodates a 42mm Lens					
* Sear	KJ02303	All Models	•	—	5.25
Sear Pivot Pin	J04201	All Models	•	.50	—
Sling Swivel Adaptor, Front	B08600	All Models	•	3.00	—
Sling Swivel Rear Mounting Stud	S-87	All Models	•	.75	—
Stock, Birch, Complete	J20441	77/50-RS	•	145.25	—
† Stock, Black Laminated, Complete	J20442	K77/50-RSBBZ	•	—	—
† Stock, Walnut, Complete	J20440	77/50-RSO	•	—	—
Striker Cross Pin	J04900	All Models	•	.50	—
Striker Head	KJ01307	All Models	•	—	7.50
Striker Shaft	KJ01308	All Models	•	—	1.25
Striker Spring	J01205	All Models	•	.50	—
* Trigger	KJ02000	All Models	•	—	10.50
Trigger Guard	J00205	All Models	•	40.00	—
Trigger Pivot Pin	D-19	All Models	•	.50	—
Trigger/Sear Spring	J02400	All Models	•	.50	—

* PARTS SO MARKED MUST BE FACTORY FITTED

† Contact the New Hampshire Service Dept. for current price. Be sure to have the complete serial number and model information before calling (603) 863-3300.

RUGER® 77/50 PERCUSSION RIFLE EXPLODED VIEW

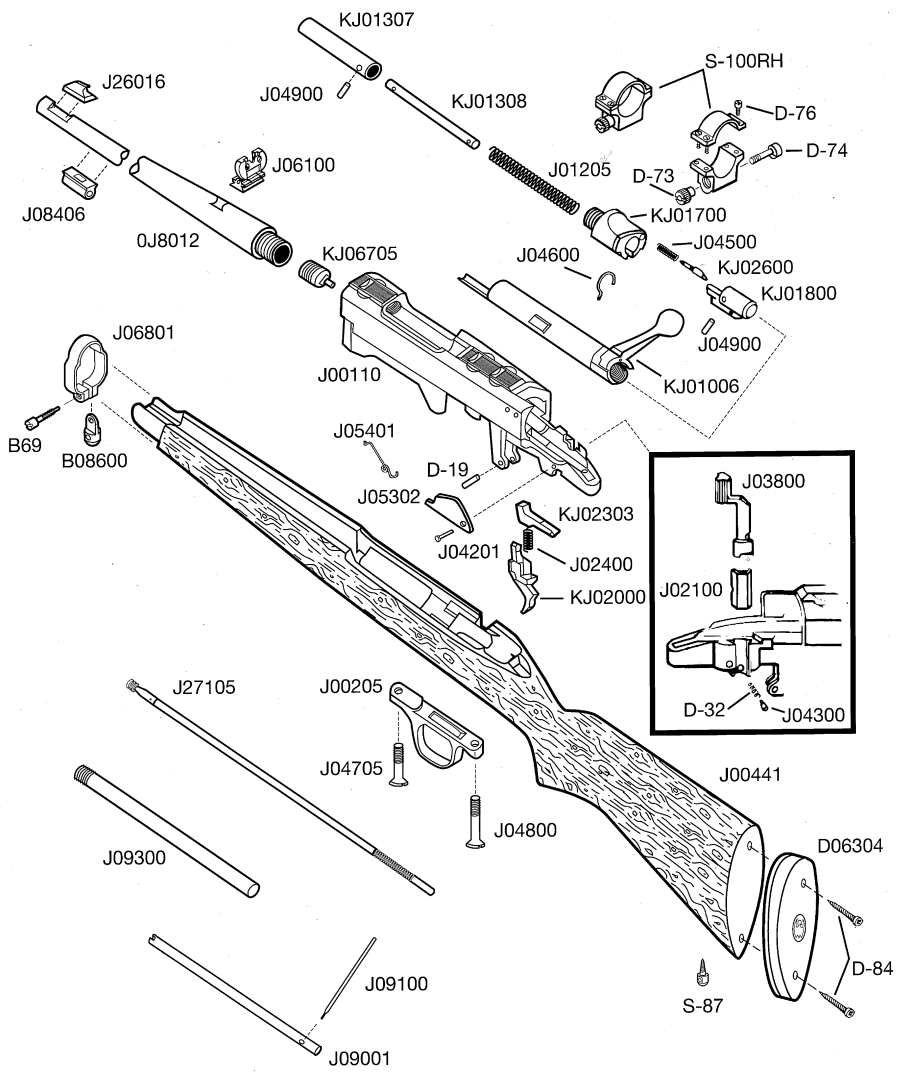

THE BASIC RULES OF SAFE FIREARMS HANDLING

We believe that Americans have a right to purchase and use firearms for lawful purposes. The private ownership of firearms in America is traditional, but that ownership imposes the responsibility on the gun owner to use his firearms in a way which will ensure his own safety and that of others. When firearms are used in a safe and responsible manner, they are a great source of pleasure and satisfaction, and represent a fundamental part of our personal liberty.

Firearms do not cause accidents! Firearms accidents are almost always found to have been the result of carelessness, or ignorance on the part of the shooter of the basic rules of safe gun handling.

The following rules must be observed by gun users at all times. Safe gun handling is not just desirable, it is absolutely essential to your safety, the safety of others, and the continuation of gun ownership and sport shooting as we know it today.

1. LEARN THE MECHANICAL AND HANDLING CHARACTERISTICS OF THE FIREARM YOU ARE USING.

Not all firearms are the same. The method of carrying and handling firearms



varies in accordance with the mechanical provisions for avoiding accidental discharge and the various proper procedures for loading and unloading. No person should handle any firearm without first having thoroughly familiarized himself with the particular type of firearm he is using, and with safe gun handling in general.

2. ALWAYS KEEP THE MUZZLE POINTED IN A SAFE DIRECTION.



Be sure of the bullet stop behind your target, even when dry-firing. Never let the muzzle of a firearm point at any part of your body or at another person. This is particularly important when loading or unloading a firearm. In the event of an accidental discharge, no injury can occur as long as the muzzle is pointing in a safe direction. A safe direction means a direction which will not permit a discharged bullet to strike a person, or to strike an object from which the bullet may ricochet.

A safe direction must take into account the fact that a bullet may penetrate a wall, ceiling, floor, window, etc., and strike a person or damage property. Make it a habit to know exactly where the muzzle of your gun is pointing whenever you handle it, and be sure that you are always in control of the direction in which the muzzle is pointing, even if you fall or stumble. Keep your finger off the trigger until you are ready to shoot.

3. FIREARMS SHOULD BE UNLOADED WHEN NOT IN USE.



Firearms should be loaded only when you are in the field or on the target range or shooting area, ready to shoot. Firearms and ammunition should be securely locked in racks or cabinets when not in use. Ammunition should safely be stored separate from firearms. Store your firearms out of sight of visitors and children. It is the gun owner's responsibility to be certain that children and persons unfamiliar with firearms cannot gain access to firearms, ammunition, or components.

4. BE SURE THE BARREL IS CLEAR OF OBSTRUCTIONS BEFORE SHOOTING.

Even a bit of mud, snow or excess lubricating oil or grease in the bore or an improperly seated bullet may cause the barrel to bulge, or even burst on firing, and can cause serious injury to the shooter and bystanders. Be sure that you are using projectiles of the proper caliber for the gun you are using. If the report or recoil on firing seems weak, or doesn't seem quite right, **CEASE FIRING IMMEDIATELY**, and check to be sure that no obstruction has become lodged in the barrel. Never try to shoot out an obstruction!

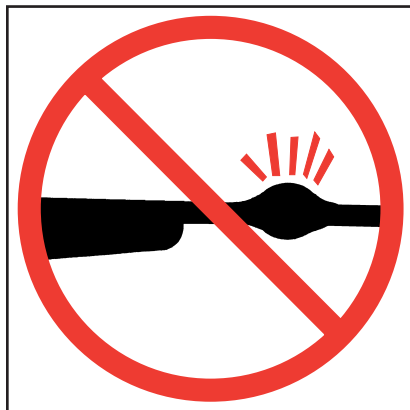



5. BE SURE OF YOUR TARGET BEFORE YOU SHOOT.

Don't shoot unless you know exactly where your bullet is going to strike. Be sure of the bullet stop behind your target, even when dry-firing with an unloaded gun. If you are in the field hunting, do not fire at a movement or noise. Take the time to be absolutely certain of your target before you pull the trigger.

6. WEAR SHOOTING GLASSES AND HEARING PROTECTORS WHEN YOU SHOOT.

All shooters should wear protective shooting glasses and adequate hearing protectors when shooting. Exposure to shooting noise can damage hearing, and adequate eye protection when shooting is essential. Bits of metal percussion cap and hot powder gasses are ejected in many directions when firing any percussion muzzleloader.



7. NEVER CLIMB A TREE OR FENCE WITH A LOADED FIREARM.

Put the firearm down carefully before climbing a fence, and remove the cap or unload it before climbing or descending a tree or jumping over a ditch or other obstruction. Never pull or push a loaded firearm toward yourself or another person. When in doubt, or whenever you are about to do anything awkward, remove the cap or unload your gun!

8. DON'T SHOOT AT A HARD SURFACE, OR AT WATER.

Bullets can glance off many surfaces like rocks or the surface of water and travel in unpredictable directions with considerable velocity.

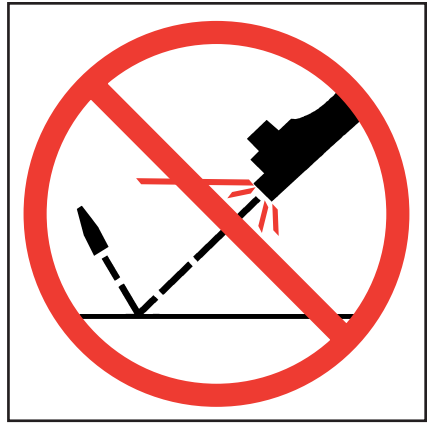

9. NEVER TRANSPORT A LOADED FIREARM.

Firearms should always be unloaded before being placed in a vehicle. A suitable carrying case or scabbard should be used to carry an unloaded firearm to and from the shooting area. With muzzleloaders, it's much easier and safer to fire them into a safe backstop before bringing them into car, camp, or home.

10. AVOID ALCOHOLIC BEVERAGES WHEN SHOOTING.

Don't drink until the day's shooting is over. Handling firearms while under the influence of alcohol in any form, or medications that could affect your judgment or co-ordination, constitutes a criminal disregard for the safety of others.



A BRIEF ACCOUNT OF AN EXTRAORDINARY ACHIEVEMENT: RUGER FIREARMS

One of the few American firearms manufacturers whose management has remained unchanged since starting in business, Sturm, Ruger & Company, Inc., had its beginning in a small machine shop occupying a rented frame building in Southport, Connecticut. In January, 1949, with an initial investment of only \$50,000 and an idea, William B. Ruger and Alexander M. Sturm started production of a .22 caliber autoloading pistol—a design which was so successful that it became the cornerstone upon which one of the most comprehensive lines of sporting firearms ever made in America was established. After Alex Sturm's death in 1951, William B. Ruger continued to direct the company alone and today, as Chairman of the Board, he is actively involved in the creative engineering of new products and continues to provide the leadership which has made this 49-year-old company a sound and successful enterprise.

Sturm, Ruger & Company, in this relatively short time, has established itself as a leading small arms design organization, developing a unique and broad line of fine quality sporting, military and police firearms to become one of the world's most famous producers of revolvers, pistols, rifles and shotguns. From 1949 thru 1998 Ruger craftsmen have built many millions of firearms.

During its four decades of growth and progress under the leadership of William B. Ruger, the company has developed a business philosophy and implemented policies which represent a constructive influence in the life of modern America. From the beginning, Sturm, Ruger & Company played a positive role in conservation efforts and has supported the interests of the National Rifle Association, National Shooting Sports Foundation, and many regional sportsmen's organizations. The company has always endeavored to market its firearms for constructive and recreational purposes, to emphasize the traditional aspects of shooting, to render meaningful public services and to encourage shooters in constructive and responsible participation in the shooting sports.

Today, Sturm, Ruger & Company is particularly mindful of those elements which have contributed to the creation of its success, and extends heartfelt thanks to its many loyal employees and customers.

A current catalog of Ruger firearms is available free upon request to
Sturm, Ruger & Co., Inc., Southport, CT 06490

WHY NO WARRANTY CARD HAS BEEN PACKED WITH THIS NEW RUGER FIREARM

The Magnuson-Moss Act (Public Law 93-637) does not require any seller or manufacturer of a consumer product to give a written warranty. It does provide that if a written warranty is given, it must be designated as "limited" or as "full" and sets minimum standards for a "full" warranty. Sturm, Ruger & Company, Inc. has elected not to provide any written warranty, either "limited" or "full", rather than to attempt to comply with the provisions of the Magnuson-Moss Act and the regulations issued thereunder. There are certain implied warranties under state law with respect to sales of consumer goods. As the extent and interpretation of these implied warranties varies from state to state, you should refer to your state statutes. Sturm, Ruger & Company wishes to assure its customers of its continued interest in providing service to owners of Ruger firearms.



STURM, RUGER & Company, Inc.
Southport, Connecticut 06490 U.S.A.
<http://www.ruger-firearms.com>

**A COPY OF THE INSTRUCTION MANUAL FOR ANY RUGER
FIREARM IS AVAILABLE FROM THE FACTORY FREE ON REQUEST.
THESE INSTRUCTION MANUALS CONTAIN IMPORTANT
WARNINGS WHICH MUST BE UNDERSTOOD
BEFORE USING THESE FIREARMS.**

"RUGER", the Sturm, Ruger logo, "SINGLE-SIX", "BLACKHAWK", "REDHAWK", "SECURITY-SIX",
"SPEED-SIX", "SERVICE-SIX", "BEARCAT", "OLD ARMY", "10/22", "MINI-14", "MINI THIRTY",
"RANCH RIFLE", "M77", "77/22", "GP-100", "SP101", "P-85" AND "VAQUERO"
are registered U.S. trademarks. "77/50" is a Ruger trademark.